

Montagehandleiding **Verano Lamellen 70 mm**

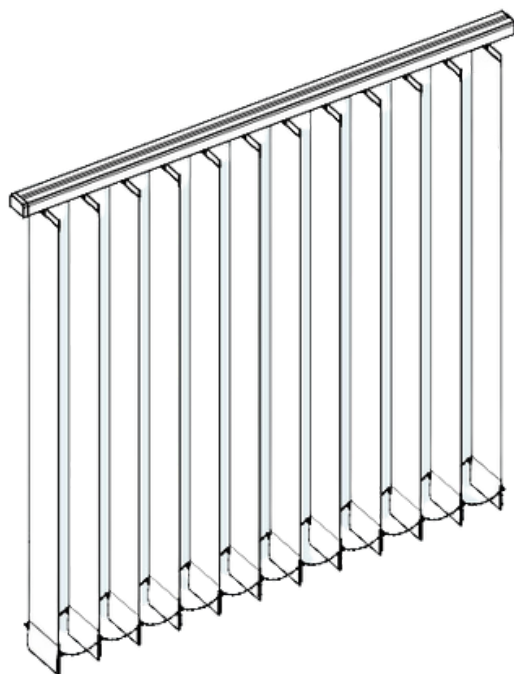

Belangrijk vóór het monteren**Waarschuwing**

Als u het Verano® product zelf monteert, is dat voor uw eigen risico. Gebruik deze instructie slechts als een hulpmiddel en alleen bij montage van dit specifieke Verano® product. Mocht u er zelf niet uitkomen, dan kunt u altijd kiezen voor professionele montage. Het montageteam van uw Verano® dealer staat graag voor u klaar.

Pas op voor beschadigingen! Gebruik geen mes of ander scherp voorwerp bij het openen van de verpakking. De inhoud zou beschadigd kunnen raken. Leg de inhoud op een zachte ondergrond.

Pas op wanneer u gaat boren. Vallend boorgruis kan beschadigingen veroorzaken.

Controleer of het kozijn of de gevel vlak is

Schroeven voor de bevestiging zijn niet bijgesloten. Gebruik altijd schroeven en pluggen welke geschikt zijn voor de wand of het plafond waarop het lamelgordijn gemonteerd wordt!

Montage



A

Plafondmontage m.b.v. clip

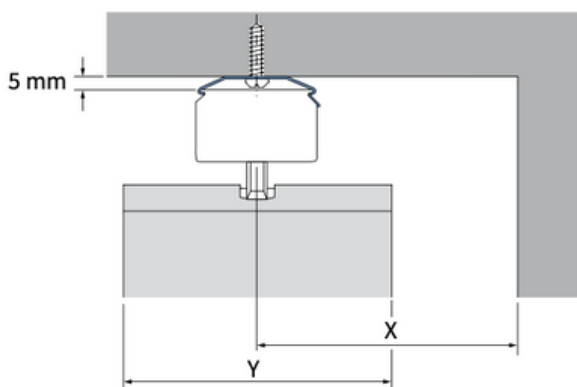
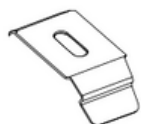

$$X = 1/2 Y + 10 \text{ mm}$$

B

Wandmontage m.b.v. afstandsteun



Z = 60 - 108 mm



Z = 108 - 156 mm

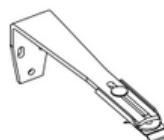

Z = 156 - 204 mm

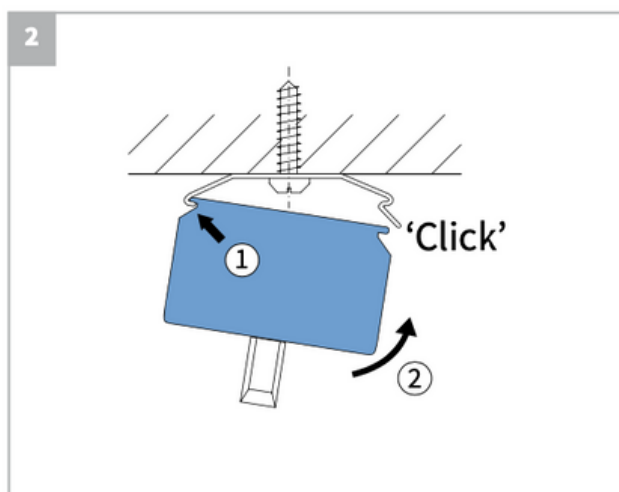
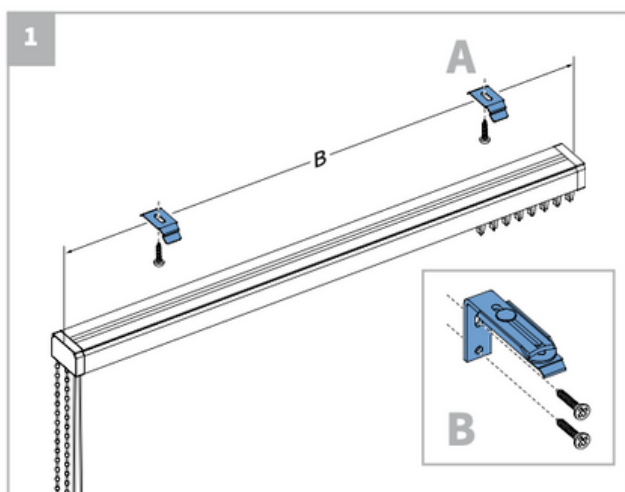
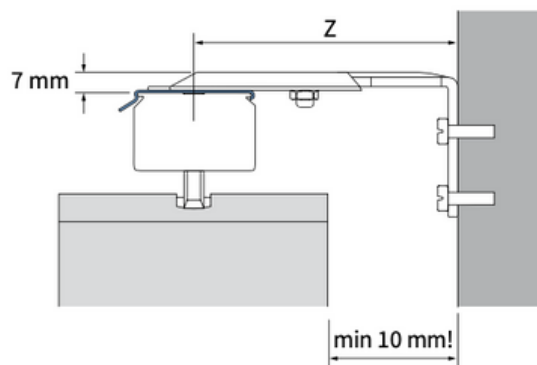

Montage

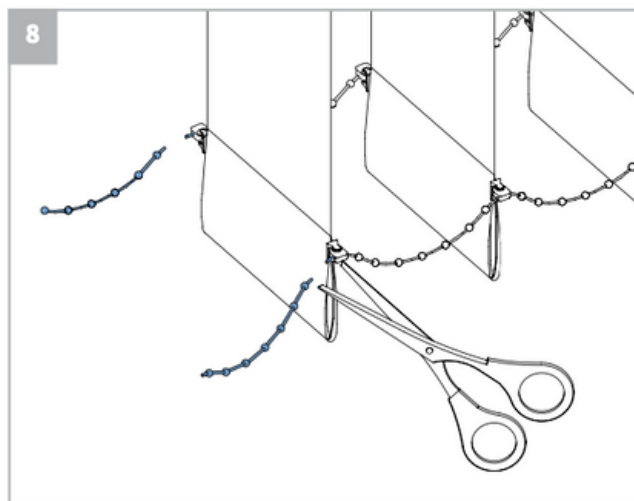
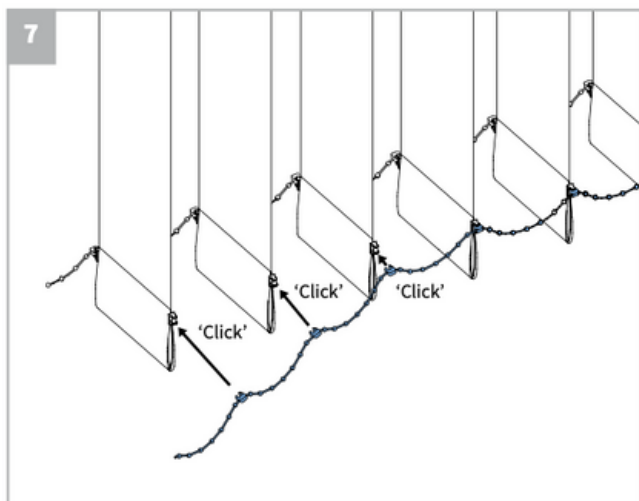
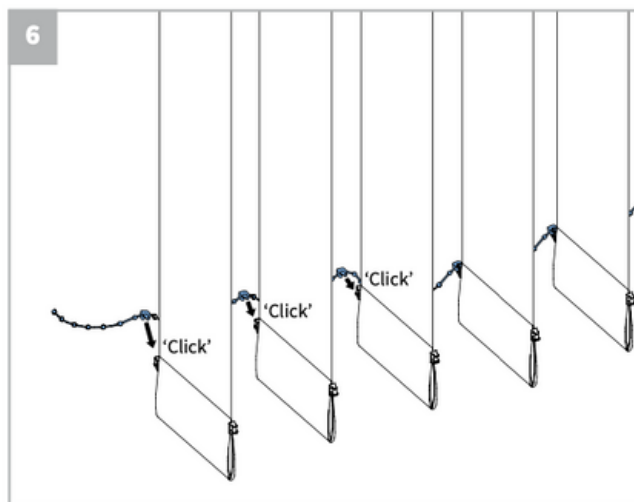
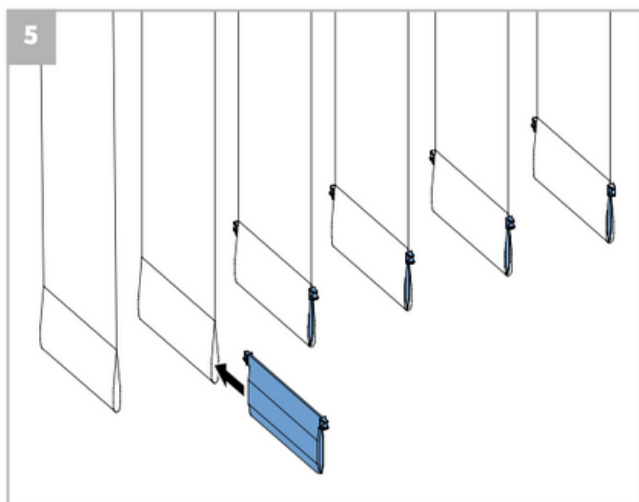
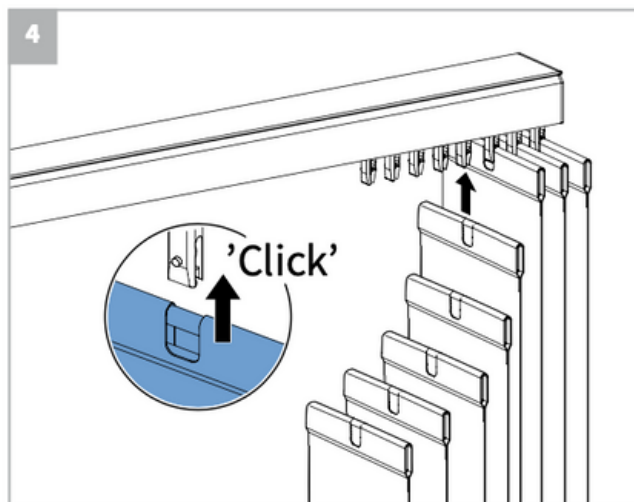
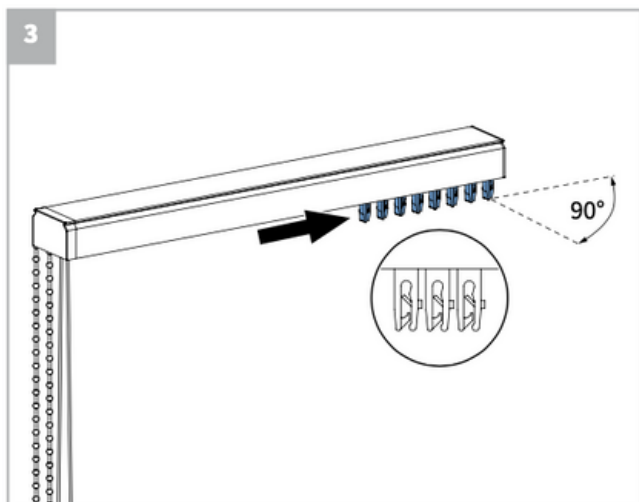

Bediening

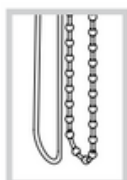
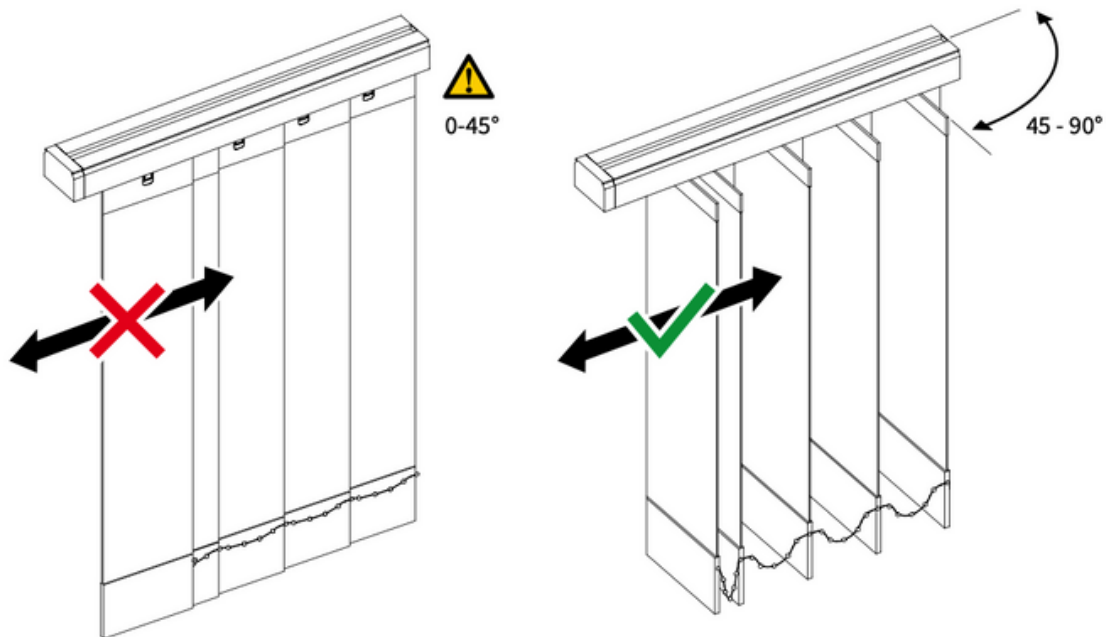

Ketting- en koordbediening

Zie pagina 10 'Kindveiligheid'

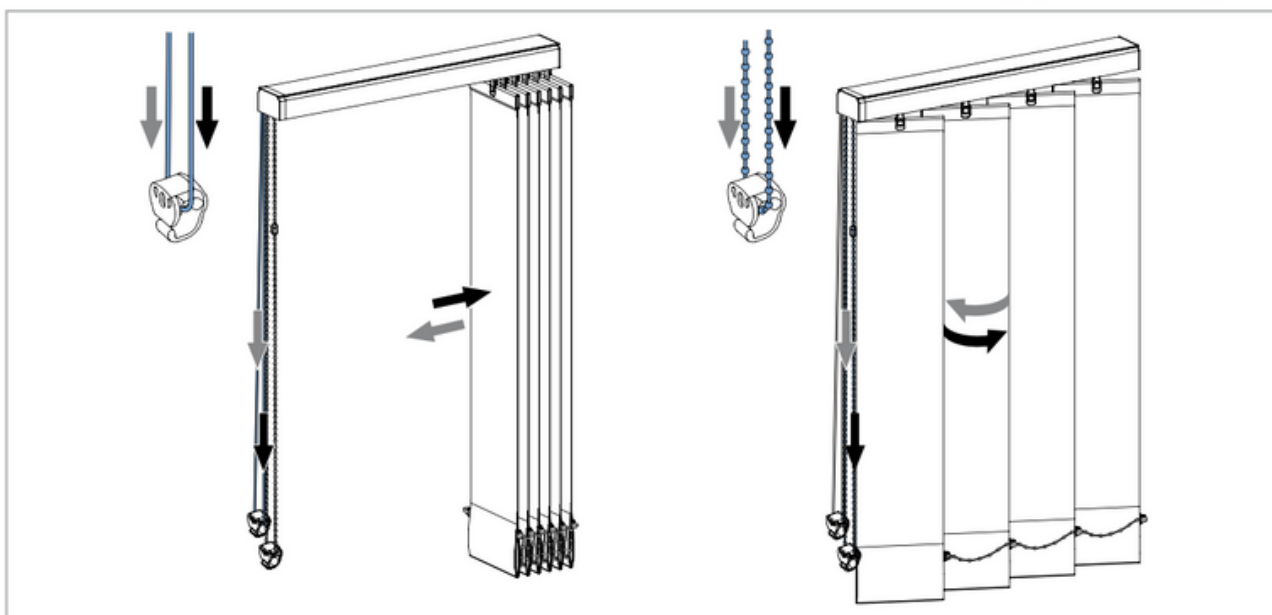



Mono-kettingbediening

 Zie pagina 10 'Kindveiligheid'

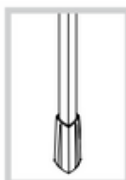
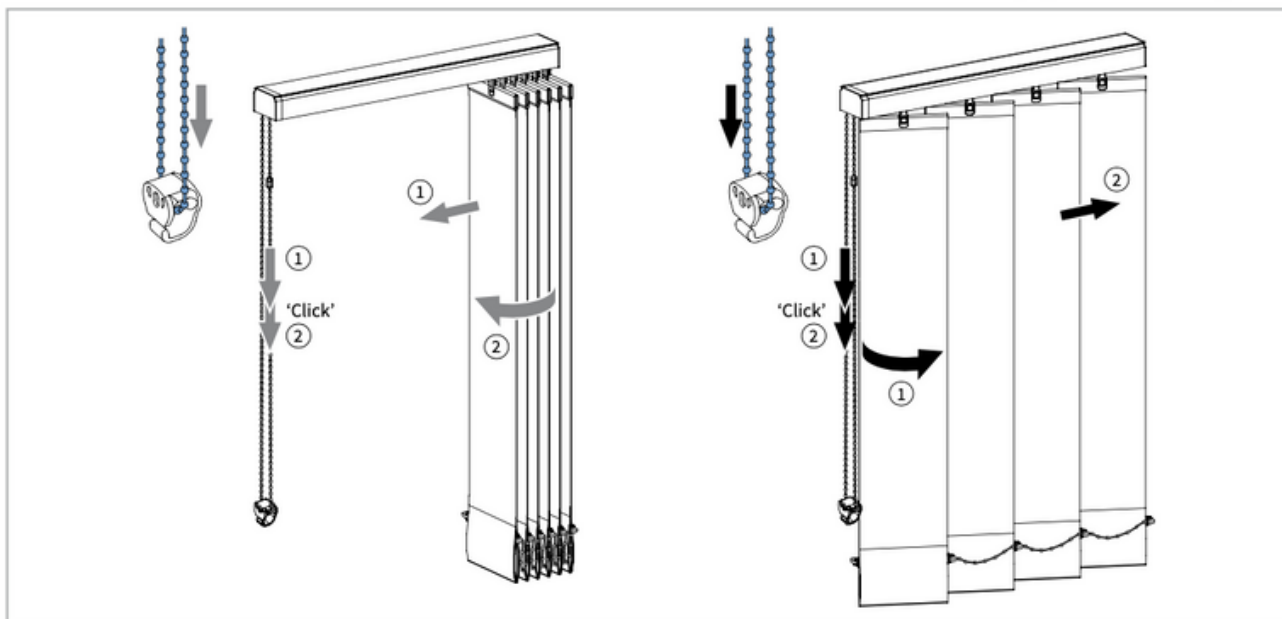

Draaistangbediening

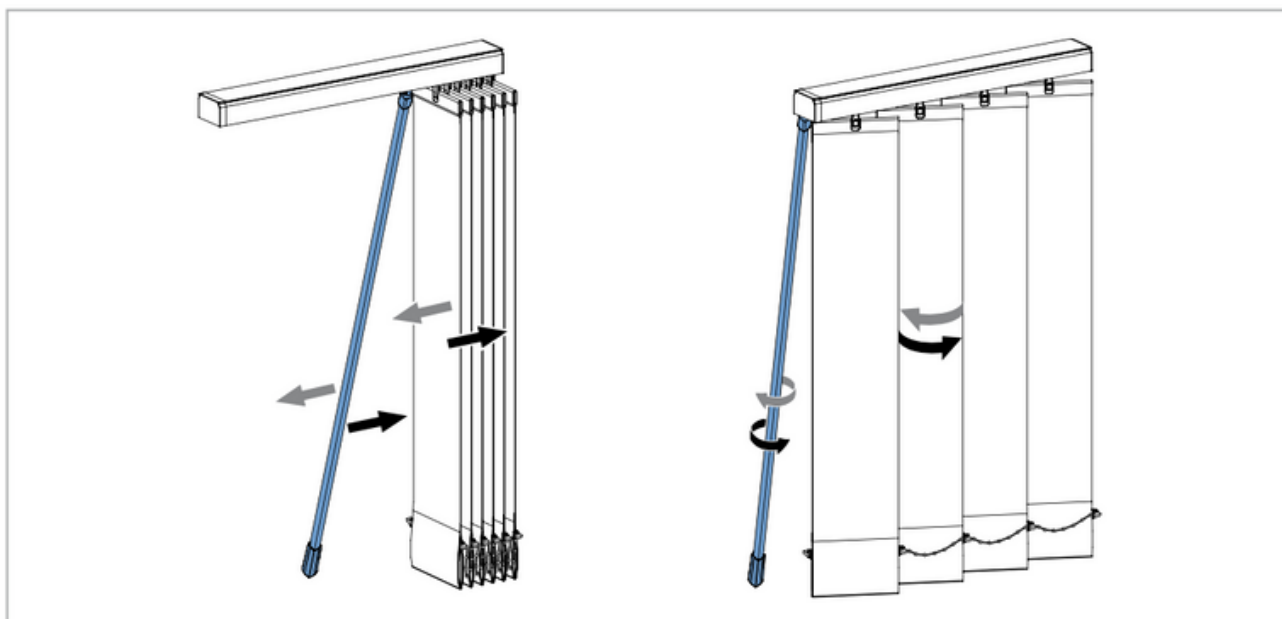

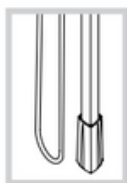

Draaistang- en koordbediening

 Zie pagina 10 'Kindveiligheid'

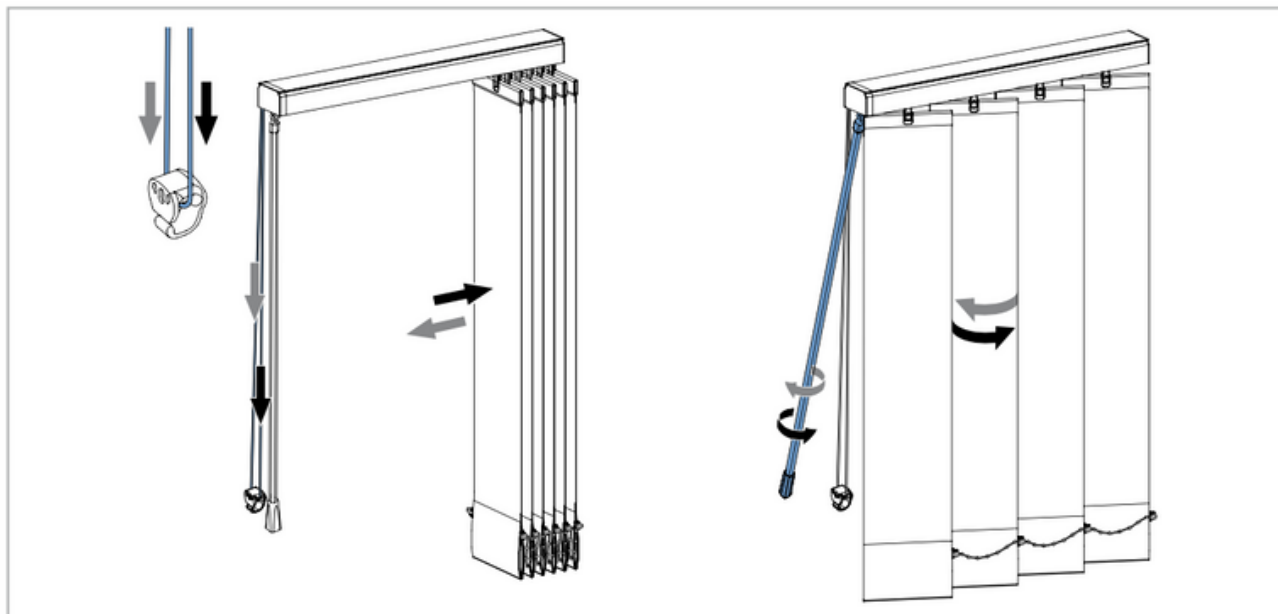

Onderhoud

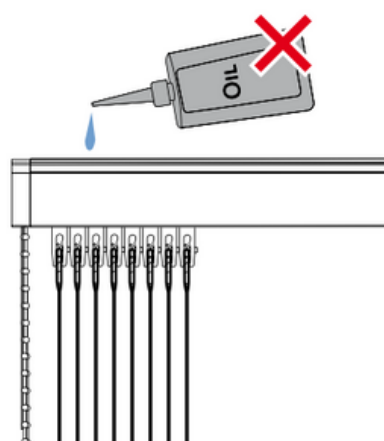
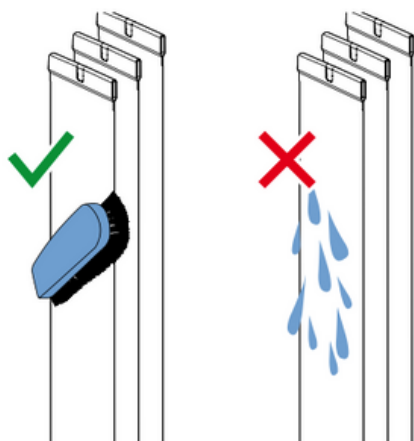
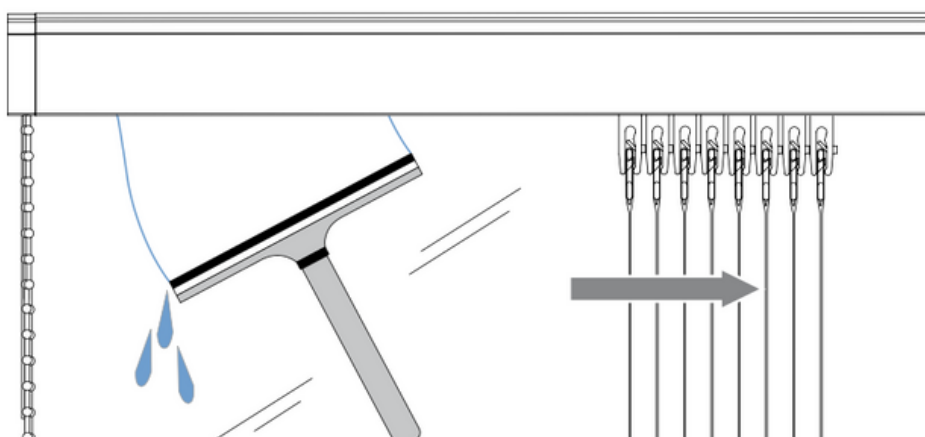
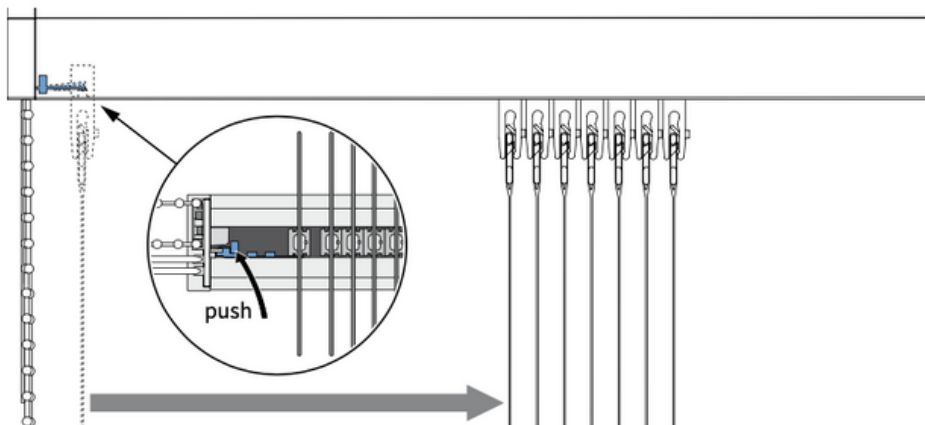

Demontage

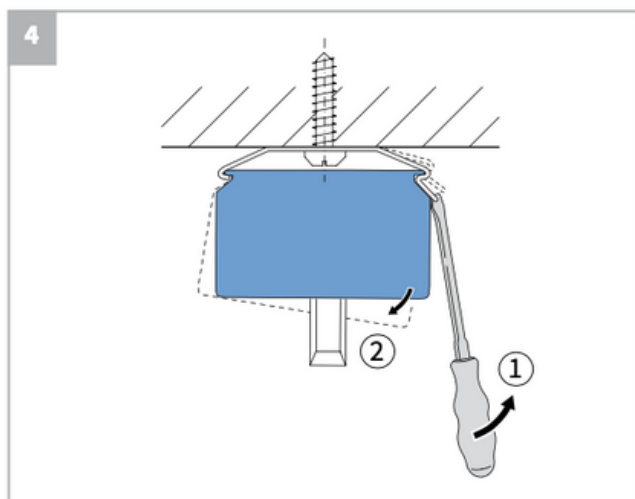
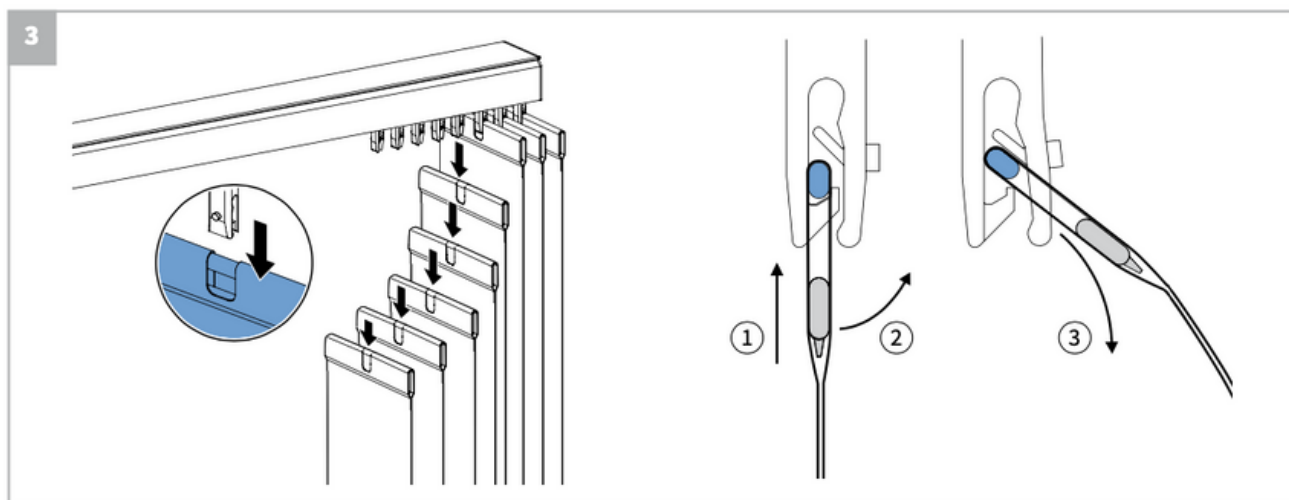
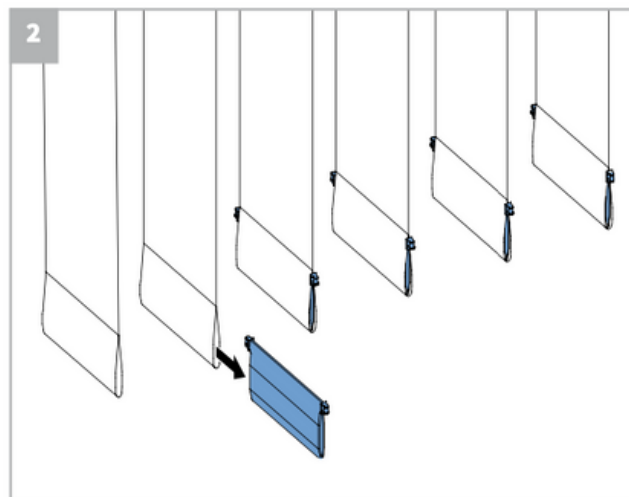
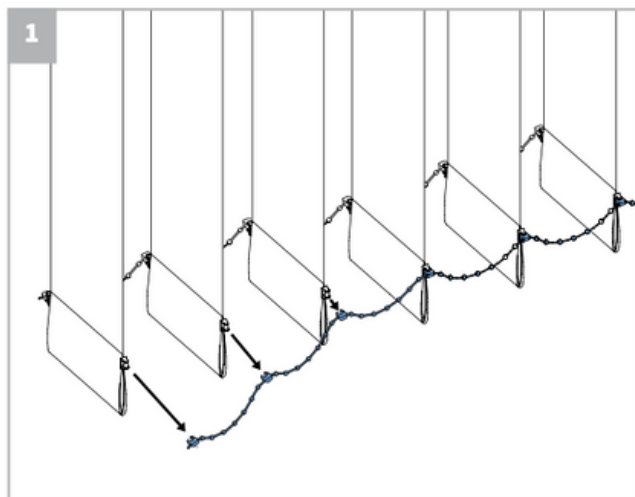

Kindveiligheid - Koord/kettingbediening

